

MN78 - Series

Larger Modular Metal Body
Position & Limit Switches



Position Switches & Limit Switches

MN78 Series - Metal Body



2 OR 4 CONTACTS

Product characteristics

- Standard switch according to DIN EN 50041, standard actuator according to DIN EN 50041
- Protection class IP66 and IP67 conforming to EN 60529
- Enclosure: Die-cast aluminium
- Cover: Aluminium
- Actuator rotatable by $8 \times 45^\circ$

Good to know ...

The MN78 is the metal version of the IN73 and designed for the use in very rough environments. A modular, robust metal enclosure with a wide range of Metalast actuators. Just as with the IN73, the MN78 offers additional fixing holes for safe installation.

It can be equipped with the C14 or C17 switch insert (2 contacts or 4 contacts).

Rough environments, outdoor areas, or high mechanical loads are all no problem for the MN78.

Position Switches & Limit Switches

MN78 Series - Metal Body

Technical design

- Slow- and snap action

- **Versions:**

With C14 switch insert: 2 NC, 2 NO, 1 NC/1 NO

With C17 switch insert: 4 NO, 4 NC, 2 NO/2 NC

1 NC/3 NO and 3 NC/1 NO

Technical data

Electrical data		
Design insulation voltage	U_i max.	400 V AC
Conventional thermoelectric current	(up to) I_{the}	5 A
Rated operating voltage	U_e max.	240 V AC / 24 V DC
Utilisation category (up to)		AC-15, U_e/I_e 240 V/3 A DC-13 U_e/I_e 24 V/1.5 A (B300 Table A.1)
Short circuit protection (up to)		Safety fuse 4 A gG
Protection class		II, protective insulation
Mechanical data		
Enclosure material		Metal, glass-fibre reinforced (UL 94-V0)
Ambient temperature		-30 °C to +75 °C
Mechanical lifetime (up to)		30×10^6 switching cycles
B10d NC Contact cycles (up to)		20 million
B10d NO Contact cycles (up to)		1 million
Switching frequency		≤ 60 /min.
Type of connection		4 screwed connections (M3)
Conductor cross-sections		Single-wire 0.5 – 1.5 mm ² or strand with wire-end ferrule 0.5 – 1.5 mm ²
Cable entry		1 × M20 × 1.5
Protection class		IP66/IP67 according to EN 60529; DIN VDE 0470 T1
Standards		

VDE 0660 T211, DIN EN 60947-5-4, IEC 60947-5-4
DIN EN ISO 13849-1, DIN EN ISO 13849-2

① Depending on switching system

Options

- Available with M12 connector
- Customised cables and connectors are available on request

Mounting

- 2 screws M5, adjustment with oval holes
- 2 screws M5 for safety applications without additional fixation required



Position Switches & Limit Switches

MN78 Series - Metal Body

MN78-... SM

Replacement actuator: 3918022415



	1 NC / 1 NO	2 NC	2 NO	2 NC / 2 NO
Slow-action system	608700002 MN78-11 SM 	608700004 MN78-20 SM 	608700006 MN78-02 SM 	608700008 MN78-22 SM
Snap-action system	608700001 MN78-S11 SM 	608700003 MN78-S20 SM 	608700005 MN78-S02 SM 	

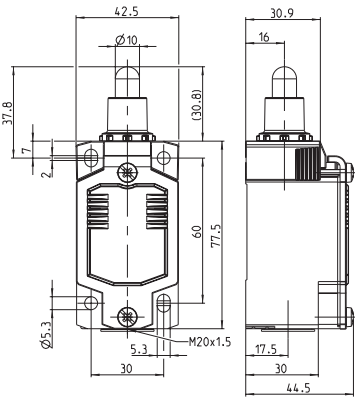

	4 NC	4 NO	3 NC / 1 NO	1 NC / 3 NO	1 NC / 1 NO overlapping
Slow-action system	608700009 MN78-40 SM 	608700010 MN78-04 SM 	608700011 MN78-31 SM 	608700012 MN78-13 SM 	608700007 MN78-V11 SM

Position Switches & Limit Switches

MN78 Series - Metal Body



Replacement actuator: 3918172417

MN78-... RM

	1 NC / 1 NO	2 NC	2 NO	2 NC / 2 NO
Slow-action system	6087000014 MN78-11 RM 	6087000016 MN78-20 RM 	6087000018 MN78-02 RM 	6087000020 MN78-22 RM
Snap-action system	6087000013 MN78-S11 RM 	6087000015 MN78-S20 RM 	6087000017 MN78-S02 RM 	

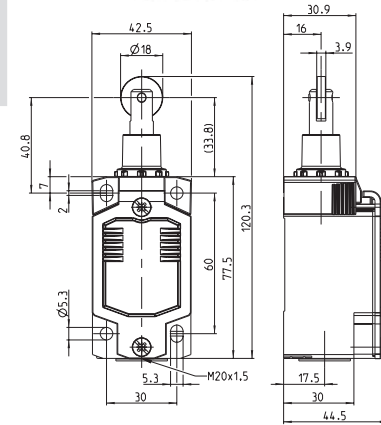

	4 NC	4 NO	3 NC / 1 NO	1 NC / 3 NO	1 NC / 1 NO overlapping
Slow-action system	6087000021 MN78-40 RM 	6087000022 MN78-04 RM 	6087000023 MN78-31 RM 	6087000024 MN78-13 RM 	6087000019 MN78-V11 RM

Position Switches & Limit Switches

MN78 Series - Metal Body

MN78-... HK

Replacement actuator: 3918202432



	1 NC / 1 NO	2 NC	2 NO	2 NC / 2 NO
Slow-action system	6087000026 MN78-11 HK 	6087000028 MN78-20 HK 	6087000030 MN78-02 HK 	6087000032 MN78-22 HK
Snap-action system	6087000025 MN78-S11 HK 	6087000027 MN78-S20 HK 	6087000029 MN78-S02 HK 	

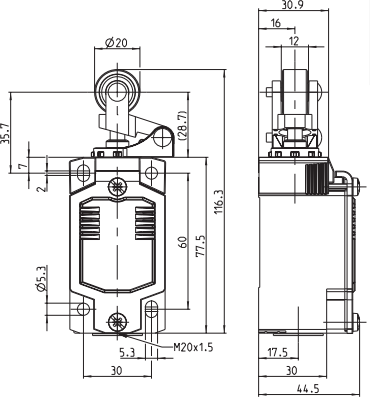

	4 NC	4 NO	3 NC / 1 NO	1 NC / 3 NO	1 NC / 1 NO overlapping
Slow-action system	6087000033 MN78-40 HK 	6087000034 MN78-04 HK 	6087000035 MN78-31 HK 	6087000036 MN78-13 HK 	6087000031 MN78-V11 HK

Position Switches & Limit Switches

MN78 Series - Metal Body



Replacement actuator: 3918202428

MN78-... DGHK

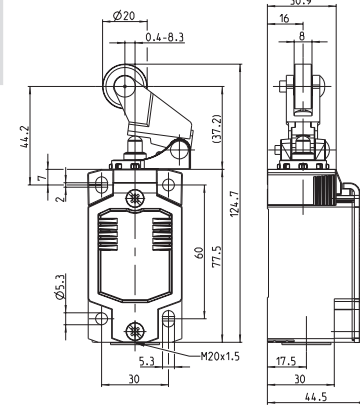

	1 NC / 1 NO	2 NC	2 NO	2 NC / 2 NO
--	-------------	------	------	-------------

Slow-action system

6087000038
MN78-11 DGHK

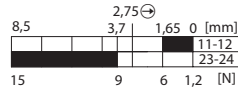

6087000040
MN78-20 DGHK

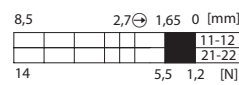

6087000042
MN78-02 DGHK

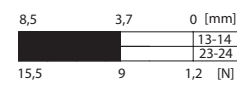

6087000044
MN78-22 DGHK

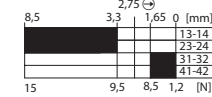

Snap-action system

6087000037
MN78-S11 DGHK

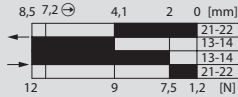

6087000039
MN78-S20 DGHK

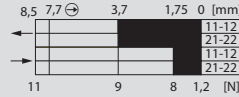

6087000041
MN78-S02 DGHK

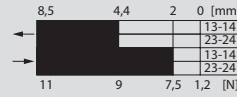

	4 NC	4 NO	3 NC / 1 NO	1 NC / 3 NO	1 NC / 1 NO overlapping
--	------	------	-------------	-------------	-------------------------

Slow-action system

6087000045
MN78-40 DGHK

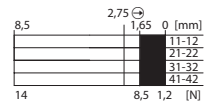

6087000046
MN78-04 DGHK

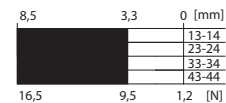

6087000047
MN78-31 DGHK

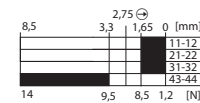

6087000048
MN78-13 DGHK

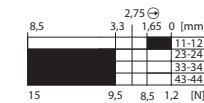

6087000043
MN78-V11 DGHK

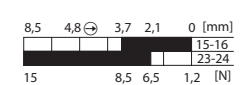

Position Switches & Limit Switches

MN78 Series - Metal Body

MN78-... DGKK

Replacement actuator: 3918202430



	1 NC / 1 NO	2 NC	2 NO	2 NC / 2 NO
--	-------------	------	------	-------------

Slow-action system

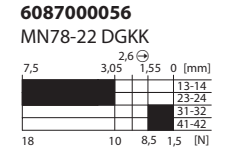
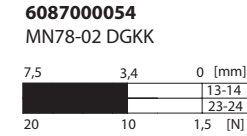
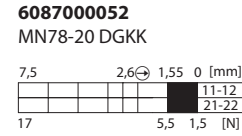
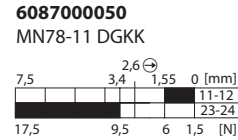

Snap-action system

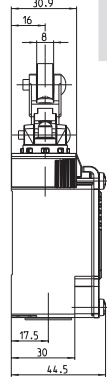
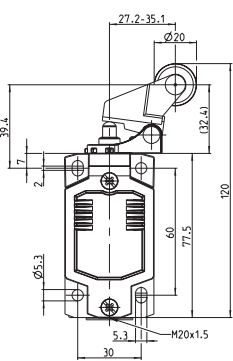
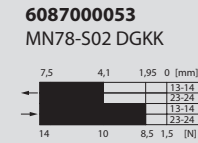
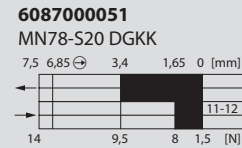
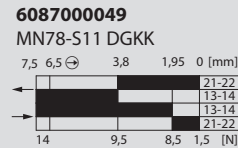

	4 NC	4 NO	3 NC / 1 NO	1 NC / 3 NO	1 NC / 1 NO overlapping
--	------	------	-------------	-------------	-------------------------

Slow-action system

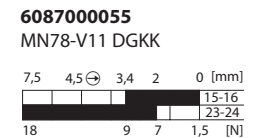
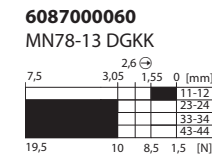
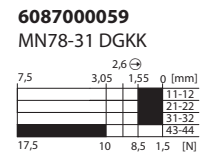
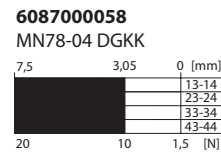
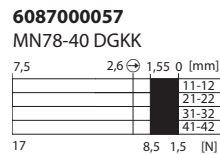

Position Switches & Limit Switches

MN78 Series - Metal Body



Replacement actuator: 3918352393

MN78-... AHK

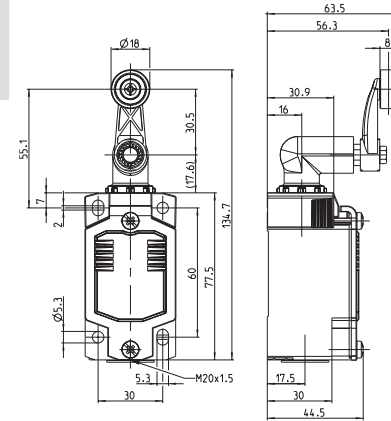

	1 NC / 1 NO	2 NC	2 NO	2 NC / 2 NO
--	-------------	------	------	-------------

Slow-action system

6087000062
MN78-11 AHK

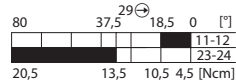

6087000064
MN78-20 AHK

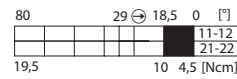

6087000066
MN78-02 AHK

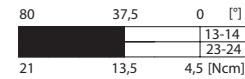

6087000068
MN78-22 AHK

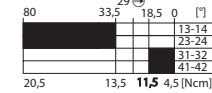

Snap-action system

6087000061
MN78-S11 AHK

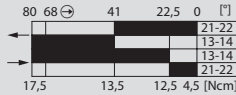

6087000063
MN78-S20 AHK

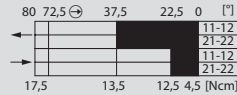

6087000065
MN78-S02 AHK

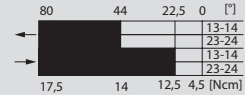

	4 NC	4 NO	3 NC / 1 NO	1 NC / 3 NO	1 NC / 1 NO overlapping
--	------	------	-------------	-------------	-------------------------

Slow-action system

6087000069
MN78-40 AHK

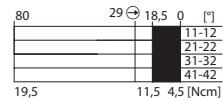

6087000070
MN78-04 AHK

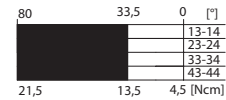

6087000071
MN78-31 AHK

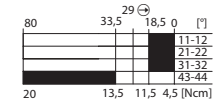

6087000072
MN78-13 AHK

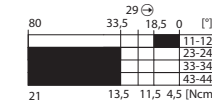

6087000067
MN78-V11 AHK

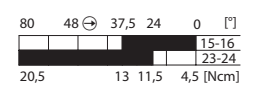

Position Switches & Limit Switches

MN78 Series - Metal Body



MN78-... AVK

Replacement actuator: 3918362424



	1 NC / 1 NO	2 NC	2 NO	2 NC / 2 NO
--	-------------	------	------	-------------

Slow-action system

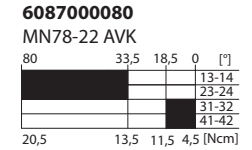
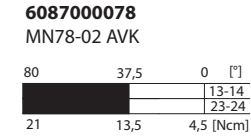
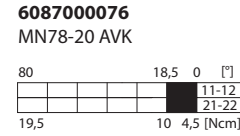
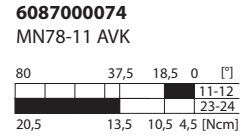

Snap-action system

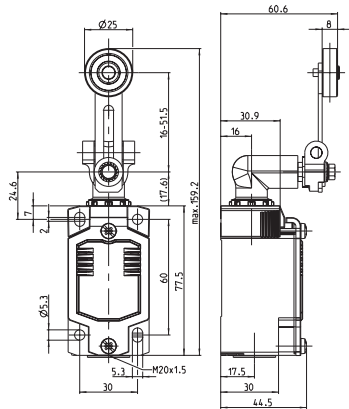
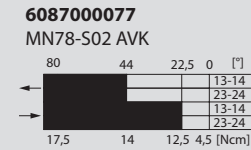
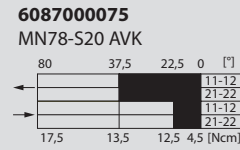
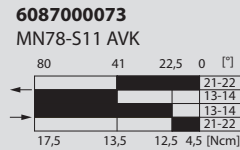

	4 NC	4 NO	3 NC / 1 NO	1 NC / 3 NO	1 NC / 1 NO overlapping
--	------	------	-------------	-------------	-------------------------

Slow-action system

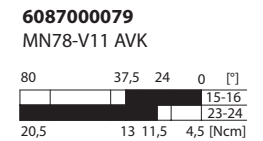
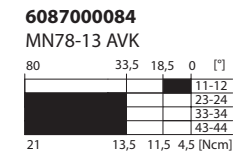
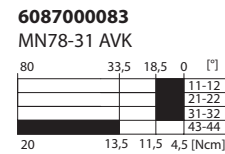
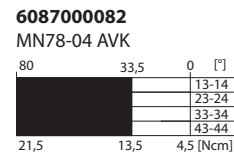
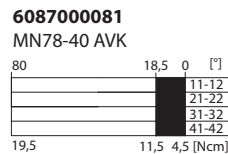

Position Switches & Limit Switches

MN78 Series - Metal Body



Replacement actuator: 3918372421

MN78-... AHDM



	1 NC / 1 NO	2 NC	2 NO	2 NC / 2 NO
--	-------------	------	------	-------------

Slow-action system

6087000086
MN78-11 AHDM

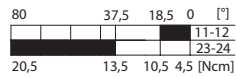

6087000088
MN78-20 AHDM

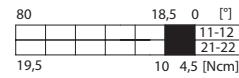

6087000090
MN78-02 AHDM

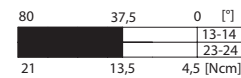

6087000092
MN78-22 AHDM

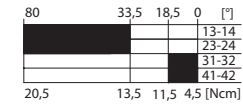

Snap-action system

6087000085
MN78-S11 AHDM

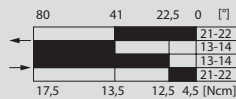

6087000087
MN78-S20 AHDM

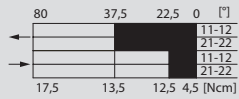

6087000089
MN78-S02 AHDM

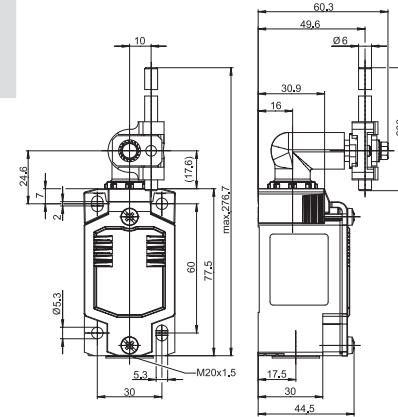
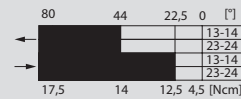

	4 NC	4 NO	3 NC / 1 NO	1 NC / 3 NO	1 NC / 1 NO overlapping
--	------	------	-------------	-------------	-------------------------

Slow-action system

6087000093
MN78-40 AHDM

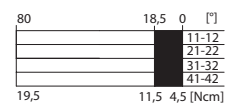

6087000094
MN78-04 AHDM

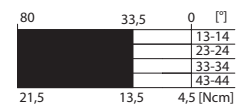

6087000095
MN78-31 AHDM

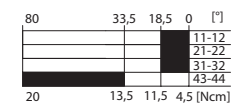

6087000096
MN78-13 AHDM

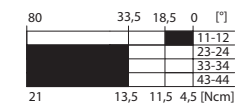

6087000091
MN78-V11 AHDM

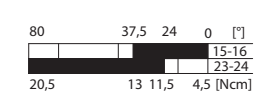

Position Switches & Limit Switches

MN78 Seperate Switch Body & Actuators



MN78 partially assembled with a switching unit

		1 NC / 1 NO	2 NC	2 NO	2 NC / 2 NO
Slow-action system	M20	6087000103 MN78-11 M20	6087000105 MN78-20 M20	6087000107 MN78-02 M20	6087000109 MN78-22 M20
	M12	6087000115 MN78-11 04	6087000117 MN78-20 04	6087000119 MN78-02 04	6087000121 MN78-22 05
Snap-action system	M20	6087000102 MN78-S11 M20	6087000104 MN78-S20 M20	6087000106 MN78-S02 M20	
	M12	6087000114 MN78-S11 04	6087000116 MN78-S20 04	6087000118 MN78-S02 04	

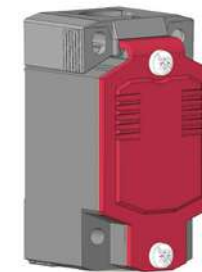

		4 NC	4 NO	3 NC / 1 NO	1 NC / 3 NO	1 NC / 1 NO overlapping
Slow-action system	M20	6087000110 MN78-40 M20	6087000111 MN78-04 M20	6087000112 MN78-31 M20	6087000113 MN78-13 M2	6087000108 MN78-V11 M20
	M12	6087000122 MN78-40 05	6087000123 MN78-04 05	6087000124 MN78-31 05	6087000125 MN78-13 05	6087000120 MN78-V11 04